

# NuKlip

## Patio Door

### Technical Catalogue

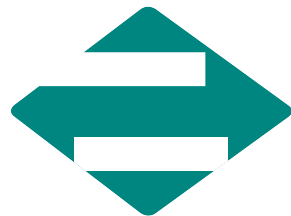

**almin**

almin metal industries limited

ALMIN PARK  
Corner Willowvale & Dagenham Roads  
Willowvale, Harare  
P O Box ST394  
Southerton  
Harare  
Zimbabwe

Telephones : +263-4-620111/2/6/7/9  
Email : [tmungure@almin.co.zw](mailto:tmungure@almin.co.zw)  
: [tmanjeya@almin.co.zw](mailto:tmanjeya@almin.co.zw)  
: [customerservice@almin.co.zw](mailto:customerservice@almin.co.zw)  
Website : [www.almin.co.zw](http://www.almin.co.zw)



## **Part 1 – System Details**

### **1. Introduction.**

The NuKlip Patio Door is Sub system of the NuKlip System.

The NuKlip System is a versatile system for Aluminium fenestration from domestic use, to high class and high performance curtainwalls on high-rise buildings whilst maintaining interchangeability of part and/or profiles.

The NuKlip Patio Door is especially designed sub system with specific uses in the sliding door market where doors are required for domestic applications, town house complexes, cluster housing, small office buildings and flat buildings. It also has a use where sliding windows are required of a more sturdy construction.

The doors use newly-designed extrusions with a double woolpile feature all round, to form a well weather-proofed sliding door.

The NuKlip Patio Door can be made in various configurations, which includes a double sliding feature.

The publication provides practical details and solutions, however, in many instances, an individual manufacturer may develop his own method of construction based on available machinery and skills.

It is known from experience that the details shown in this publications are accepted practices in the industry and that weatherproofing is maintained with the details indicated.

In this case of major deviations from suggested details it is recommended that tests are performed to ensure adequate weatherproofing such as water ingress, air infiltration and deflection under the specified windloading.

The design of NuKlip Patio Door does make provision for top and/or side light configurations. These details are indicated in separate publication.

With the NKPDHI, the heavy duty interlock section, heavier wind loading conditions can be catered for, depending on the overall sizes and configuration of the sliding door or sliding window.

The NuKlip Patio Door uses the well-proven, popular channel gasket as its glazing system.

Weatherproofing is achieved by the use of double woolpile in the outer frame sections and the interlocks profiles, thus giving a double barrier against wind and water infiltration. The recommended types of woolpile are indicated in the list of components later in this publication.

An interlock "Sentry" Lock provides secure locking of NuKlip Patio Door.

This publication indicates some alternatives solutions, and the HiRise interlock.



## 2. Design Basis & System usage

**Design Basis** of NuKlip Patio Door included the following main requirements:

1. A minimum of machining, with mainly square cutting,
2. Minimum number of profile sections,
3. Good weather protection,
4. Ease of operation,
5. Must accept safety glass thickness from 4mm to 6.5mm.
6. Standard configurations must be able to accept standard TSG blanks.
7. Double sliding for total flexibility,
8. Ease of maintenance.

### **System Usage** of the NuKlip Patio Door

This sliding door can be used in both standard and non-standard configurations – the min panel width should not be less than 750 mm and max should not exceed 1500 mm with overall height of 2100 mm, using the standard profiles. For higher and/or wider configurations contact Aluminium City, or consider using the NuKlip Galaxy Sliding Door.

**NuKlip Patio Door Stile  
SIZE LIMITATION CHART at 740Pa**

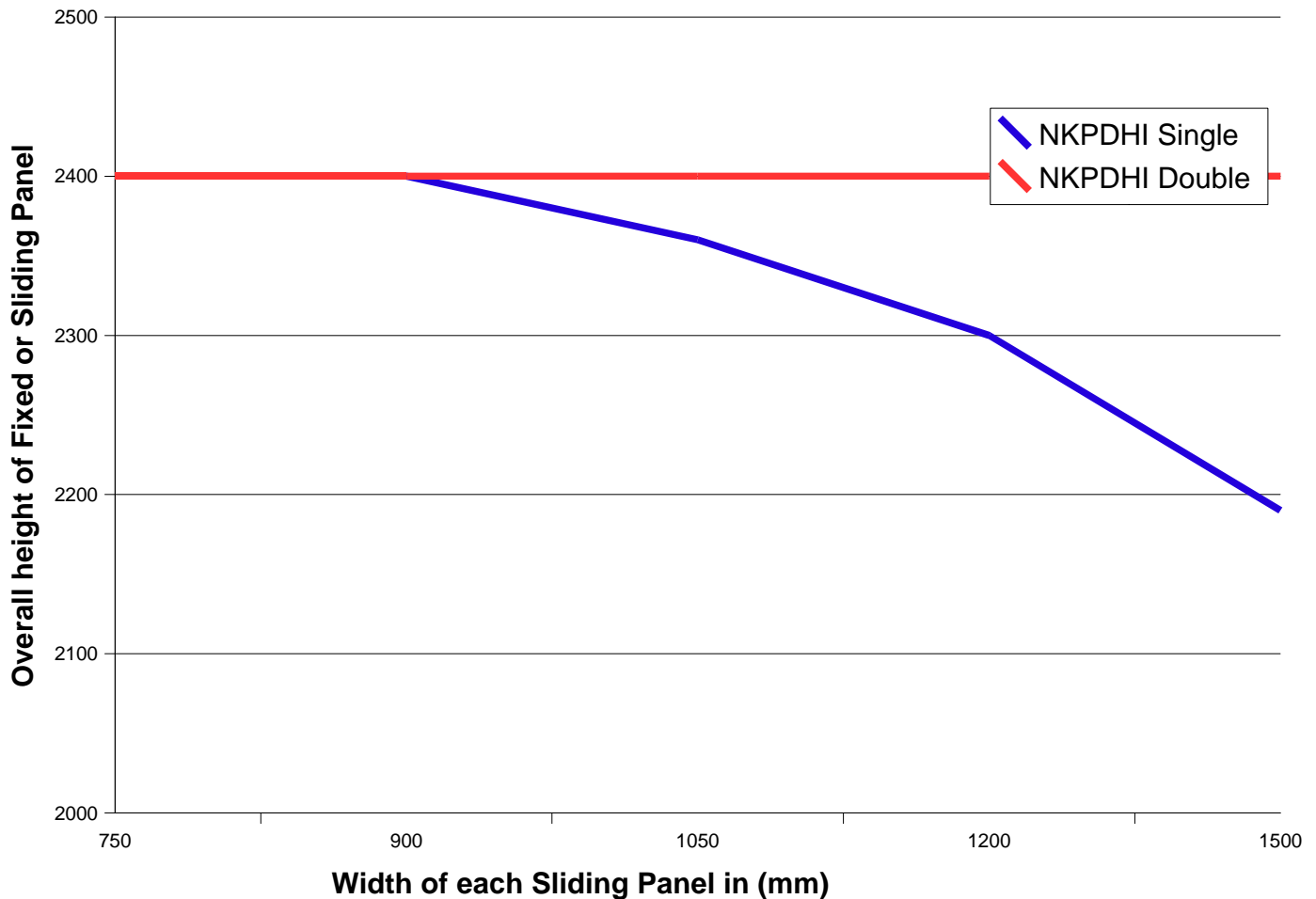

The chart above indicates the maximum height in mm of the unsupported door stiles under the 740 Pa Wind Loading as may specified by the client or professional Team. The interlock stiles are typical examples of unsupported door stiles.

A supported door stile would be the lock stile which is fully supported by the frame side, which in turn is fixed to the carcass work of the building.

When the NKPDHI (NuKlip Patio HiRise Interlock) is used on both inside and outside face of the sliding , the "Double" notation in the on the chart is applicable.

The "Single" notation on the chart means that only one of the interlocks is HiRise whilst the other interlock could be standard.

**Note:**

The Patio Door System is suitable for use as a sliding window in high-rise applications, balcony enclosures, office blocks and hotels

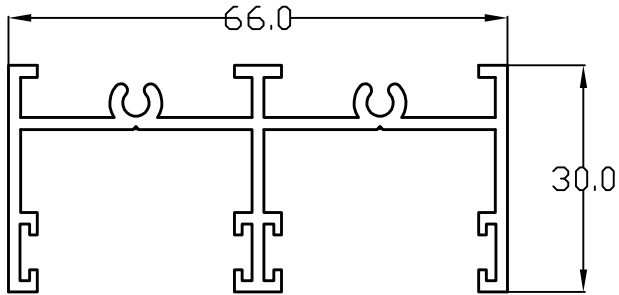

NKPDFT  
44664

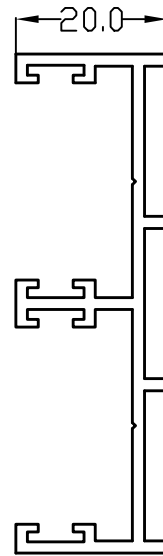

NKPDFSM  
44655

NKPD SW  
44805

NKPD CW  
44804

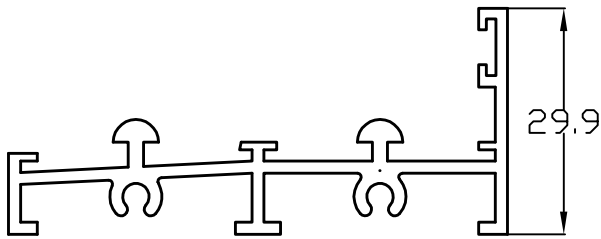
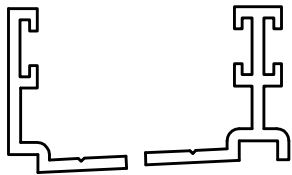

NKPDFB  
44656

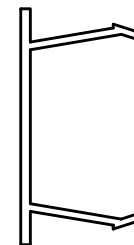

NKPD CO  
44668

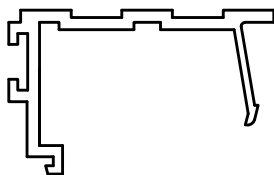

NKPD OS  
44665

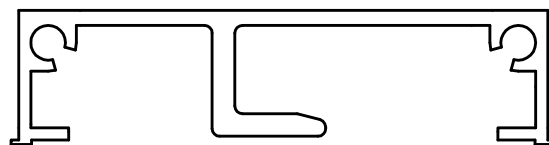

NKPD STRK

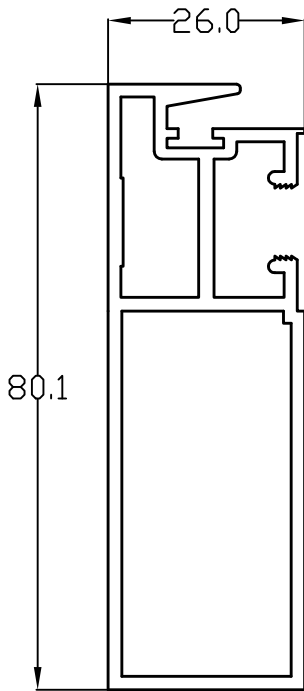

NKPDHIM  
H7551

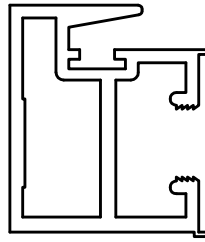

NKPDILM  
H7552

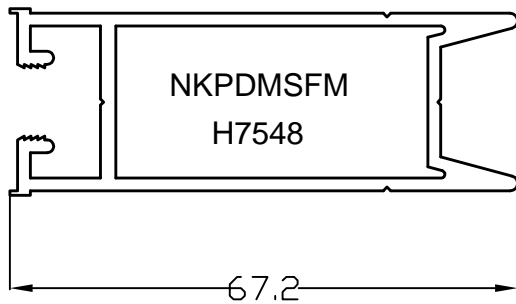
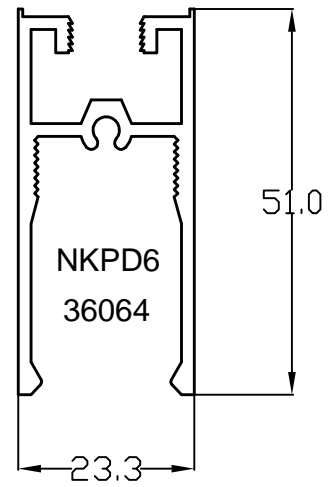

NKPDMSFM  
H7548



NKPDMSML  
H7549

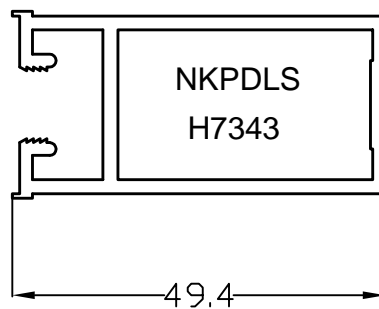

NKPDLS  
H7343

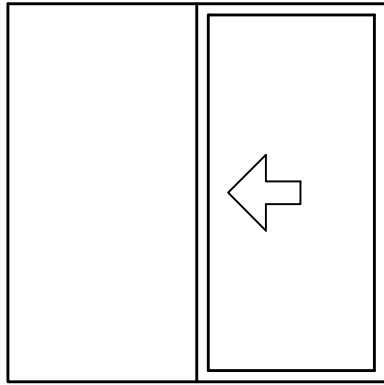

OX

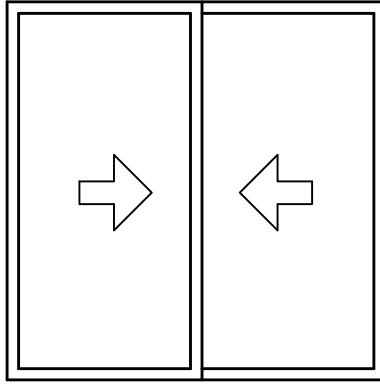

XX

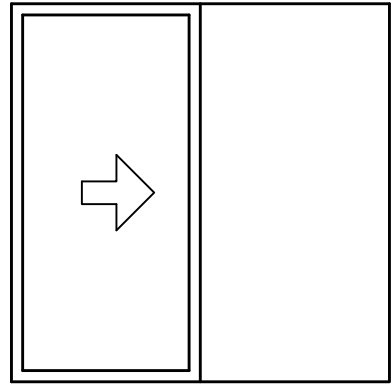

XO

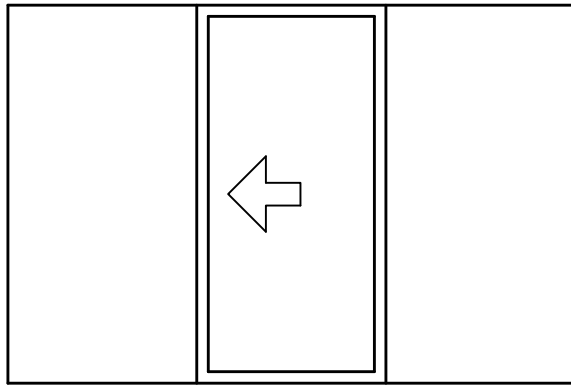

OXO

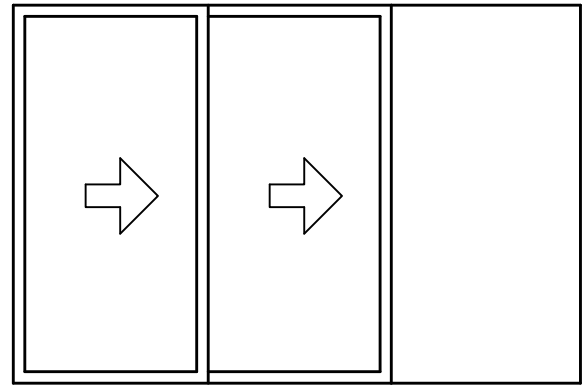

XXO (Not Stocked)

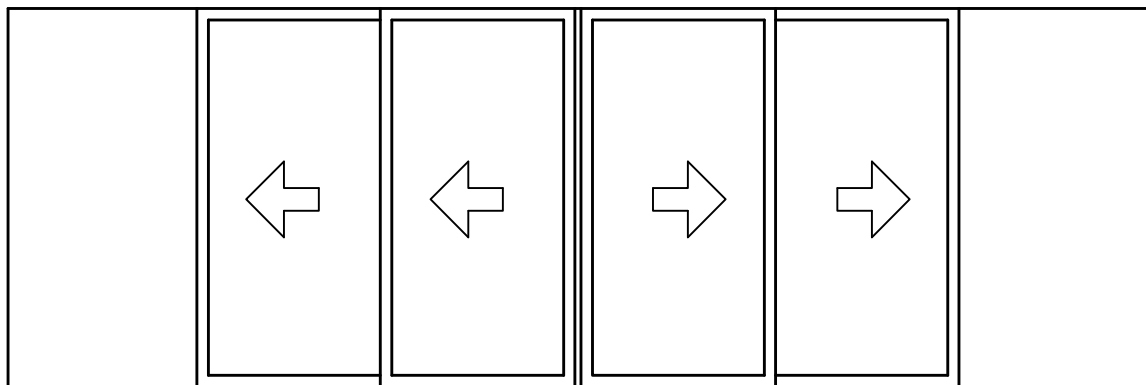

OXXXXO (Not Stocked)

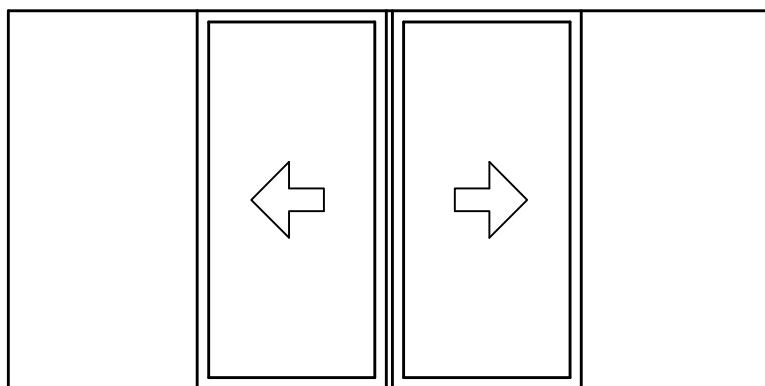

OXXO

SLIDING DOORS TYPES

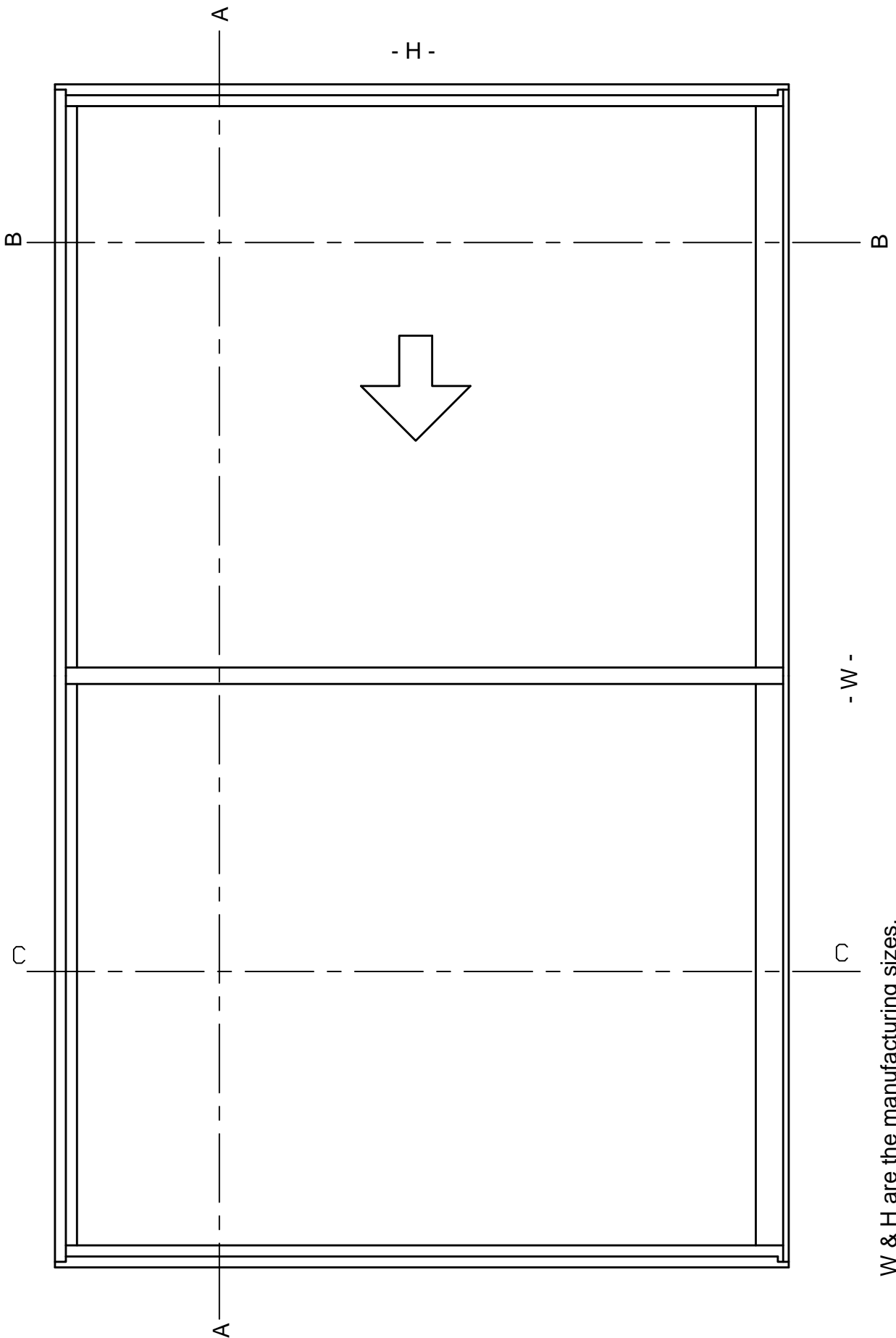

W & H are the manufacturing sizes,  
NOT the opening sizes in the building.  
OX TYPE SLIDING DOOR





## SECTION A - A

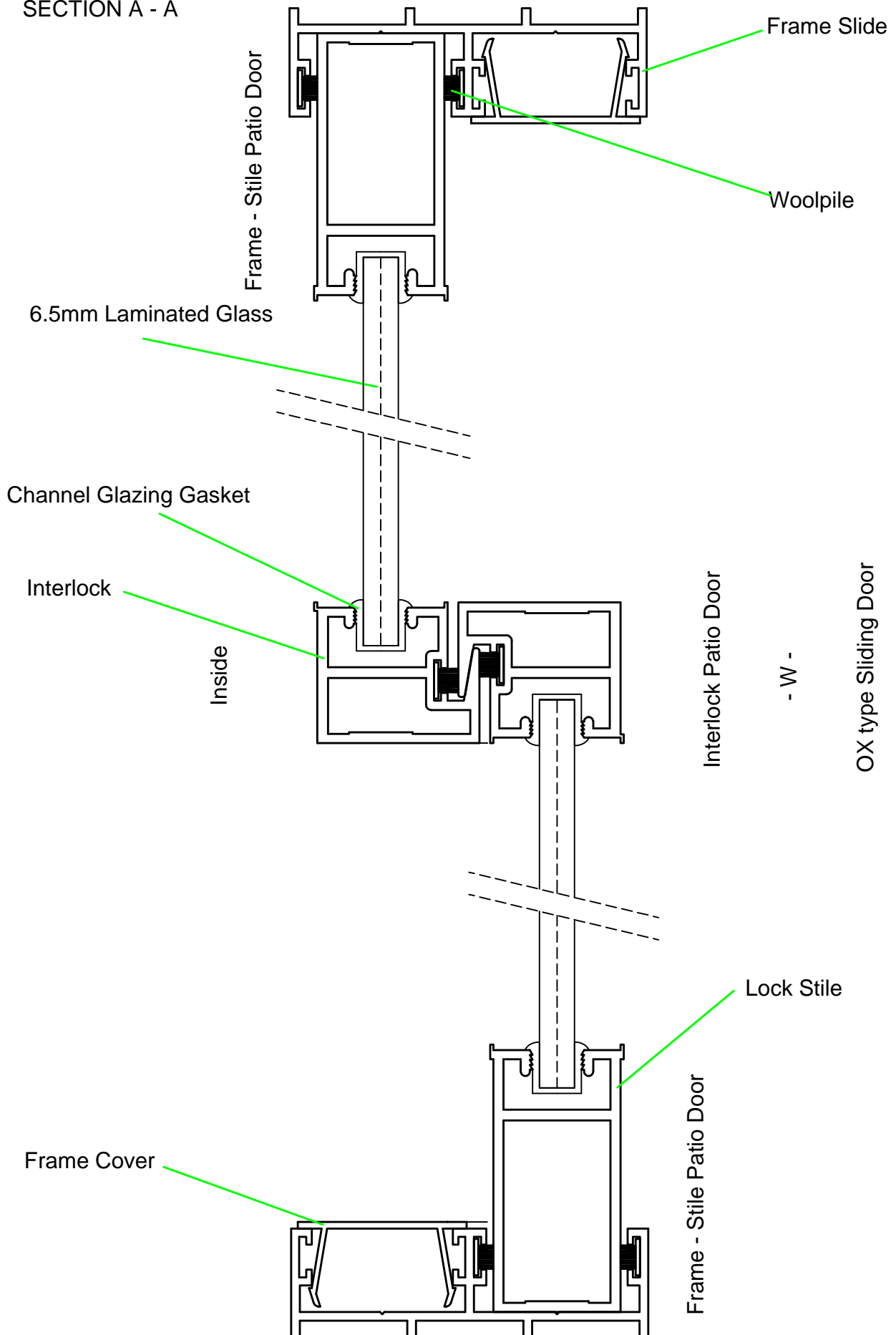



## SECTION B - B

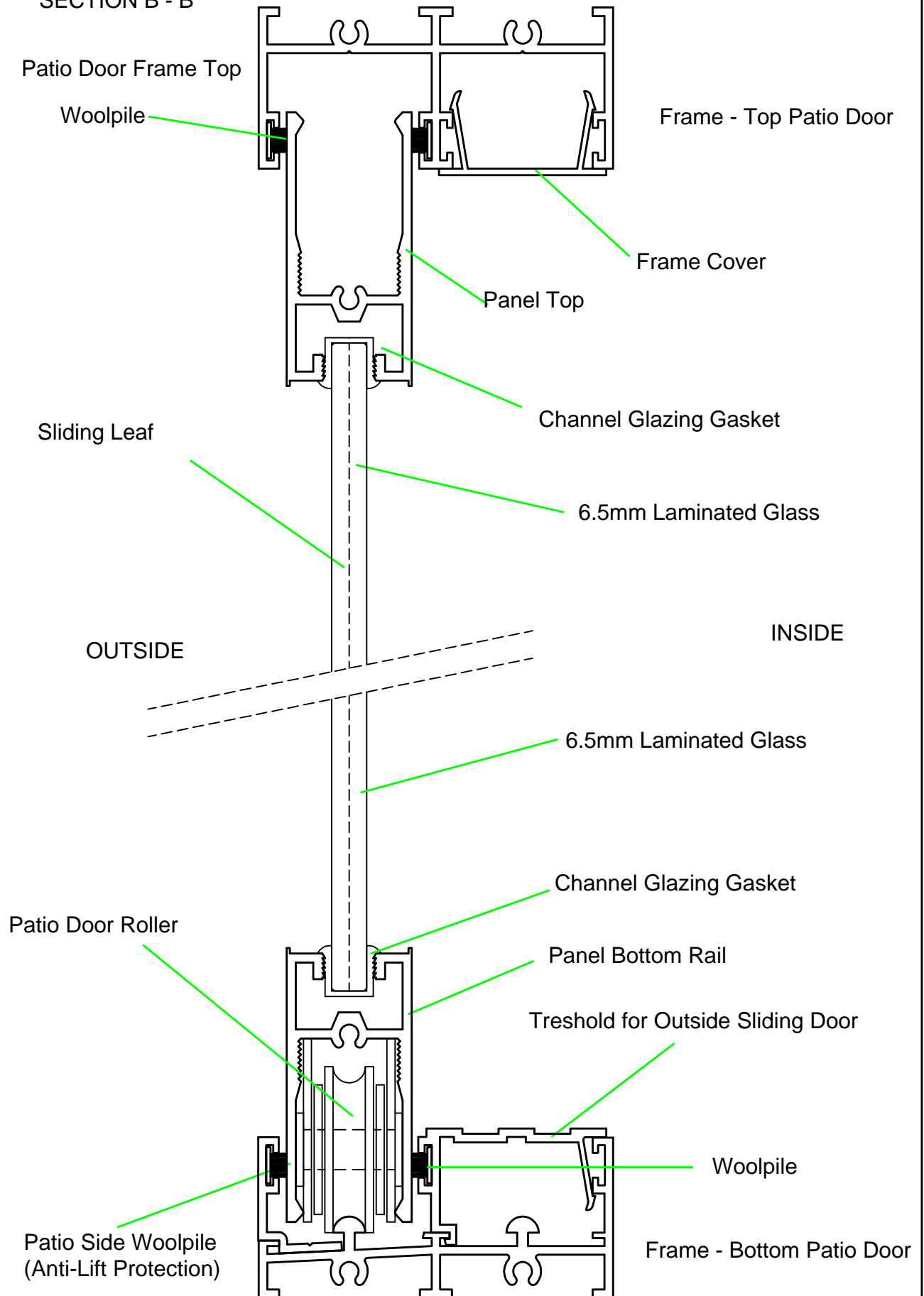

Section through Sliding Part of OX, OXO & OXXO Type Sliding Doors  
Vertical Cross Sections



SECTION C-C

Frame - Top Patio Door

Fixed Leaf

OUTSIDE

INSIDE

ROLLER OR HARDWOOD/NYLON  
BLOCK MACHINED TO FIT

Patio Centre Woolpile  
(Guide & Weather Proofing)

Patio Side Woolpile  
(Anti-Lift Protection)

Frame - Bottom Patio Door

Section through Sliding Part of OX, OXO & OXXO Type Sliding Doors  
Vertical Cross Sections

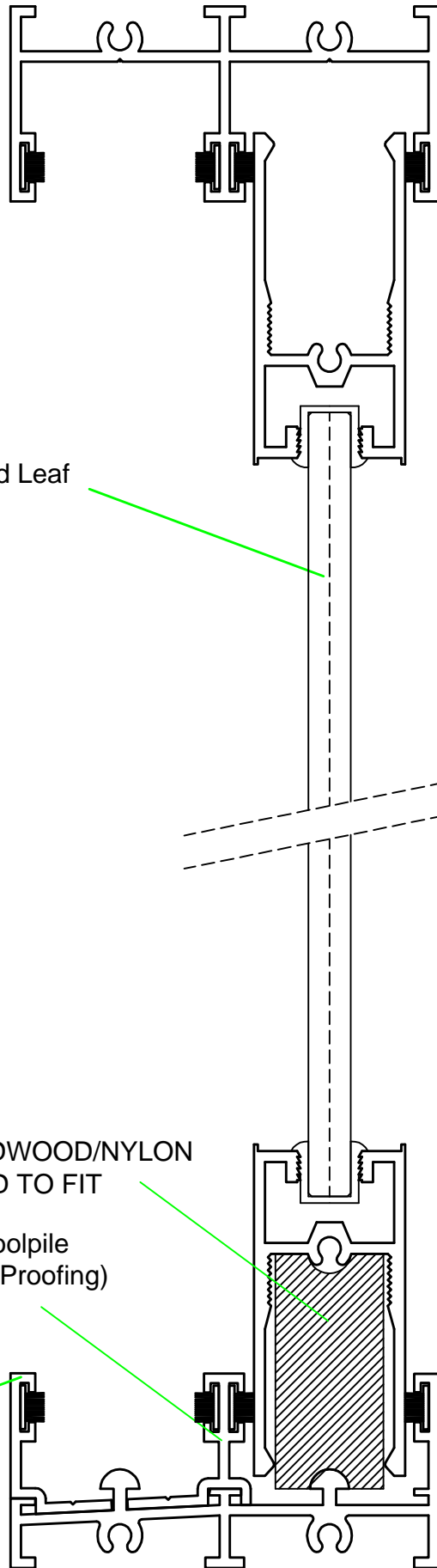



SECTION A - A

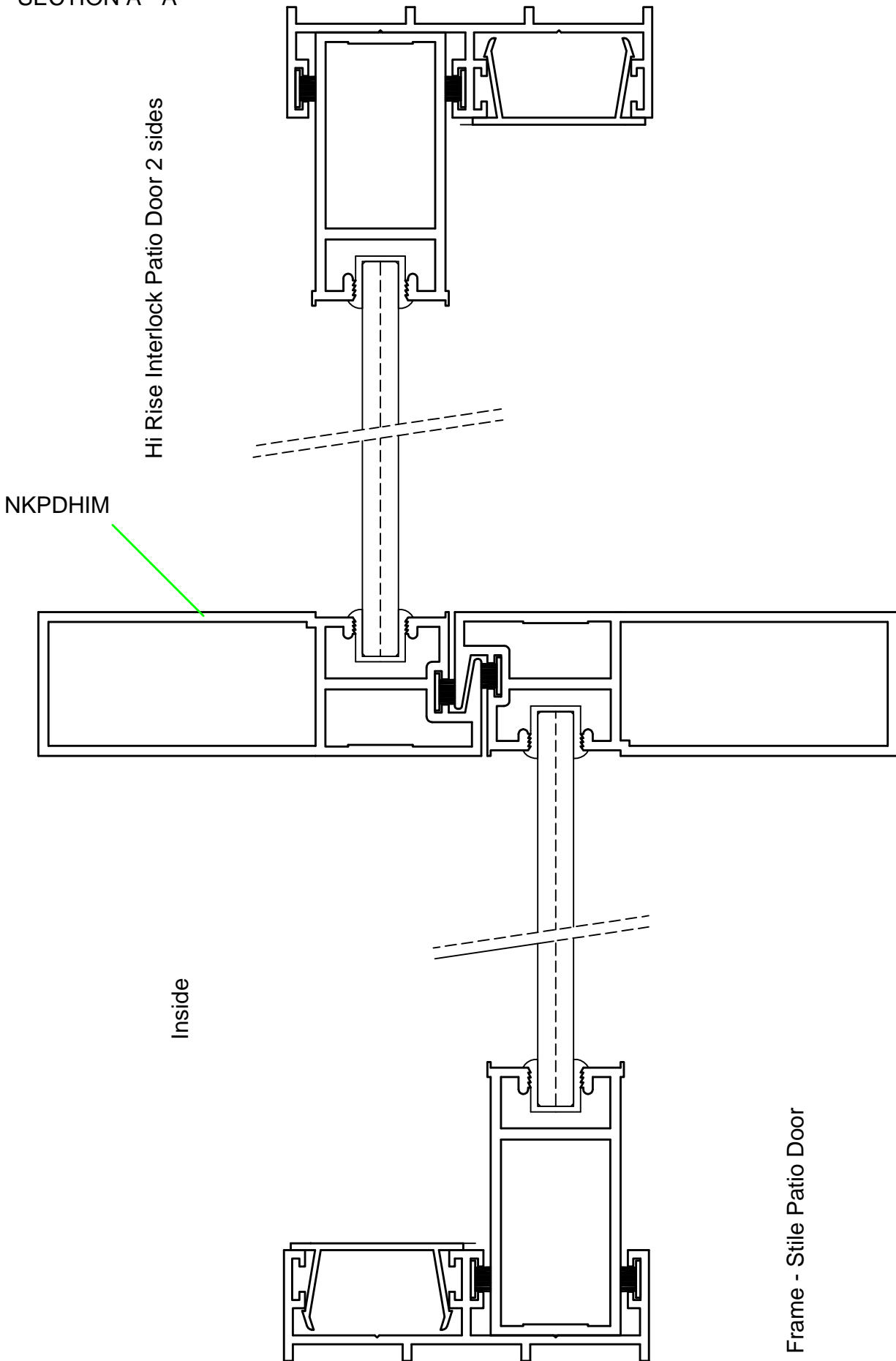

Alternative Cross Sections and Details



SECTION A - A

Hi Rise Interlock Patio Door 2 sides

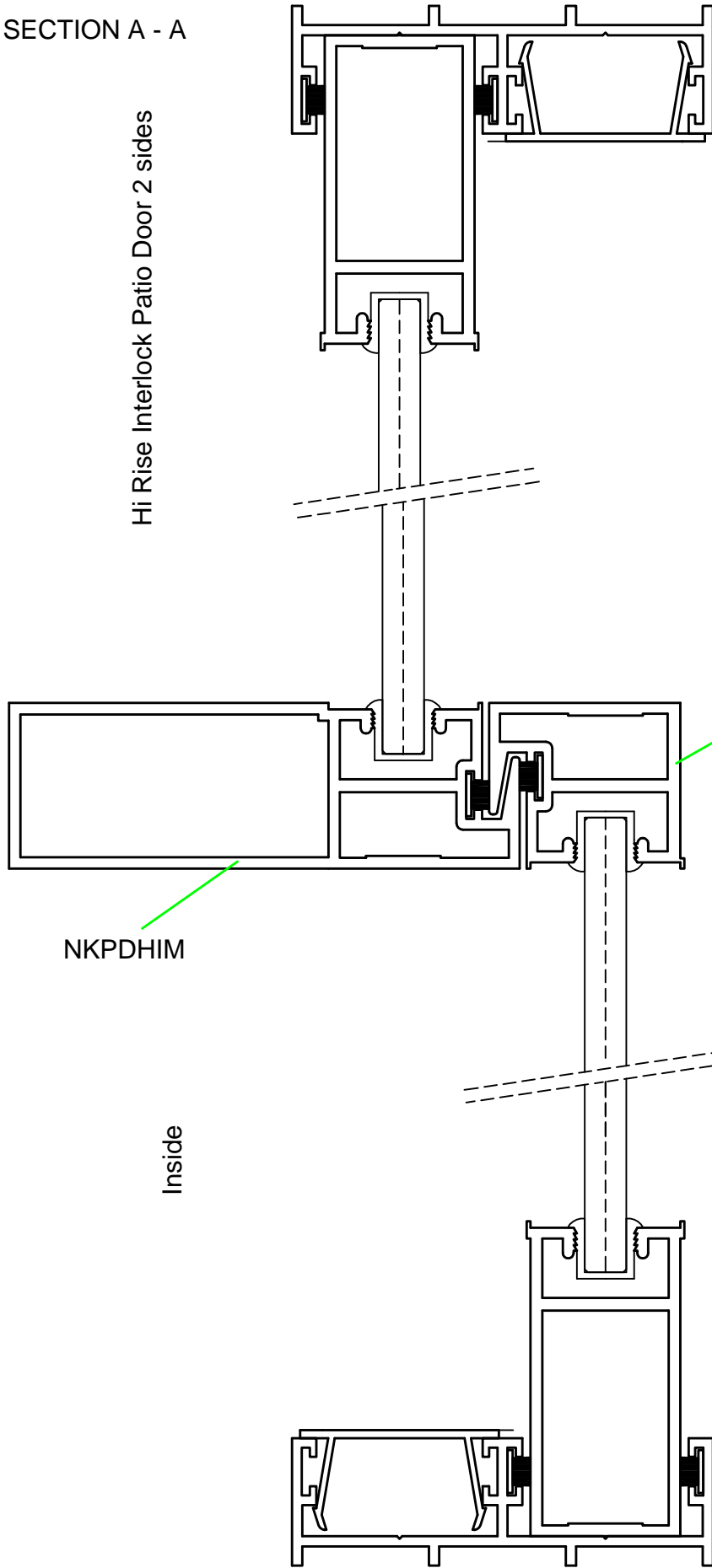

NKPDHIM

NKPDHILM

Inside

Single Sliding Door with Hi-Rise Interlock both sides (Hor Section)

Frame - Stile Patio Door

Alternative Cross Sections and Details

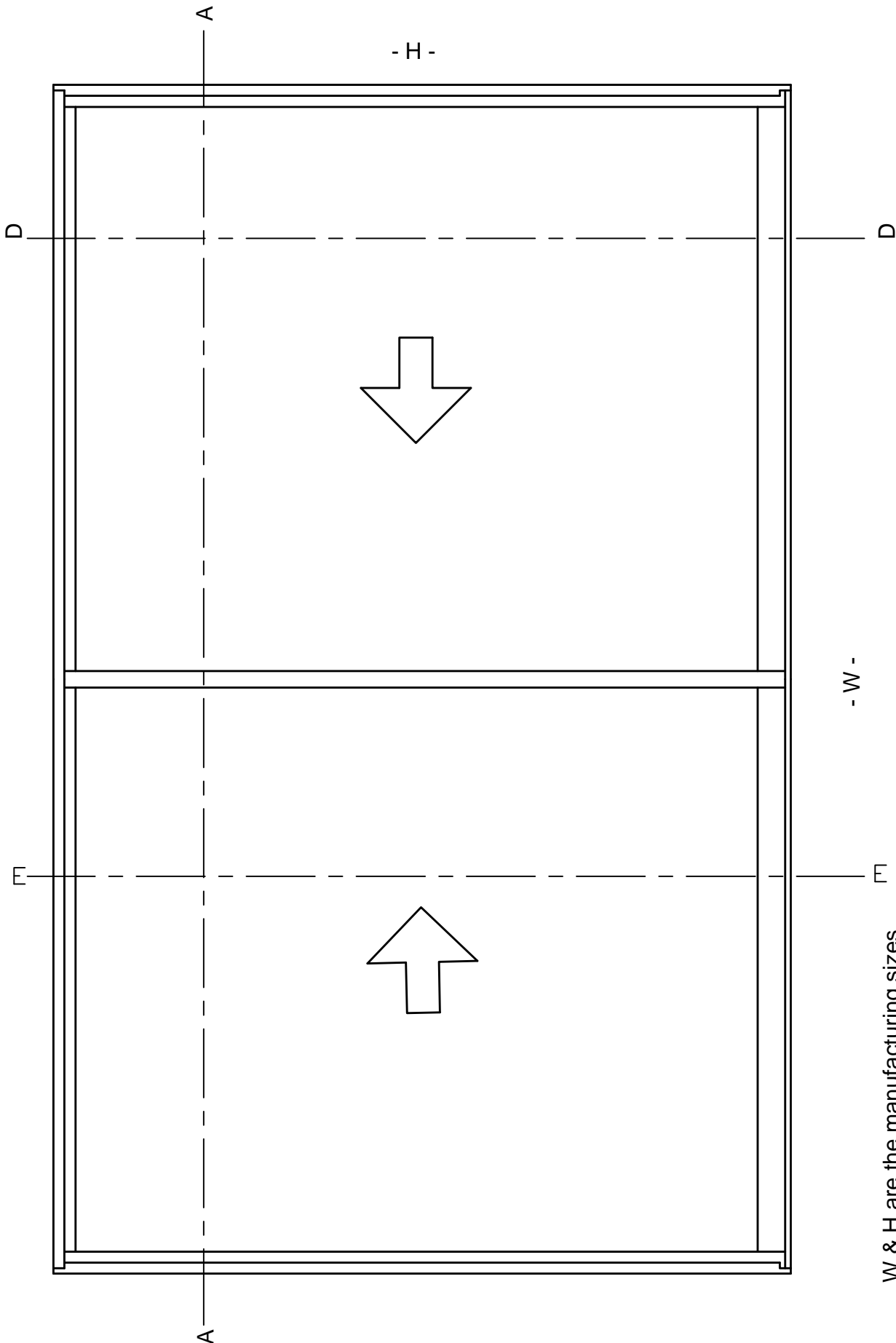

W & H are the manufacturing sizes,  
NOT the opening sizes in the building.

XX TYPE SLIDING DOOR



## SECTION A - A

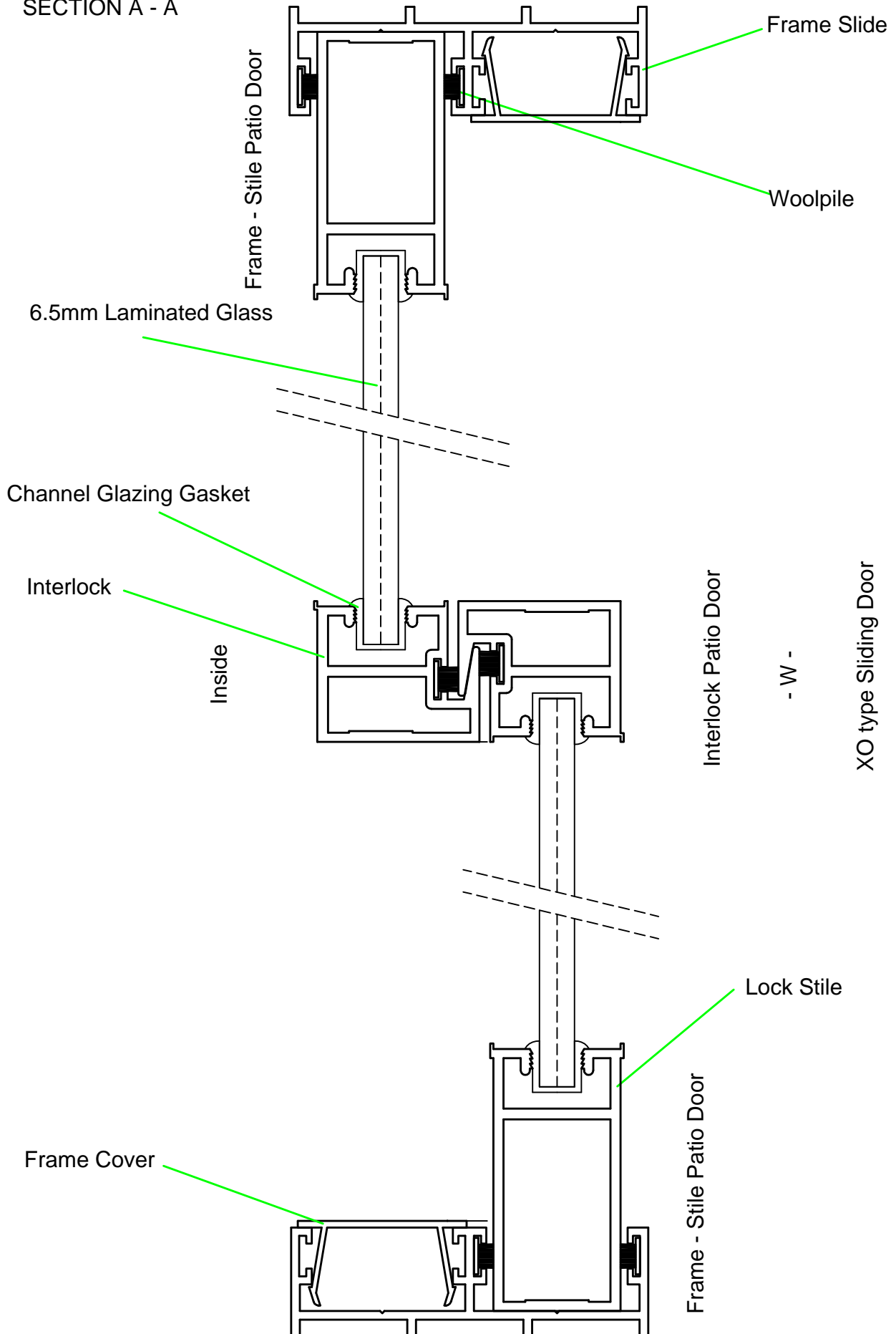



SECTION D - D

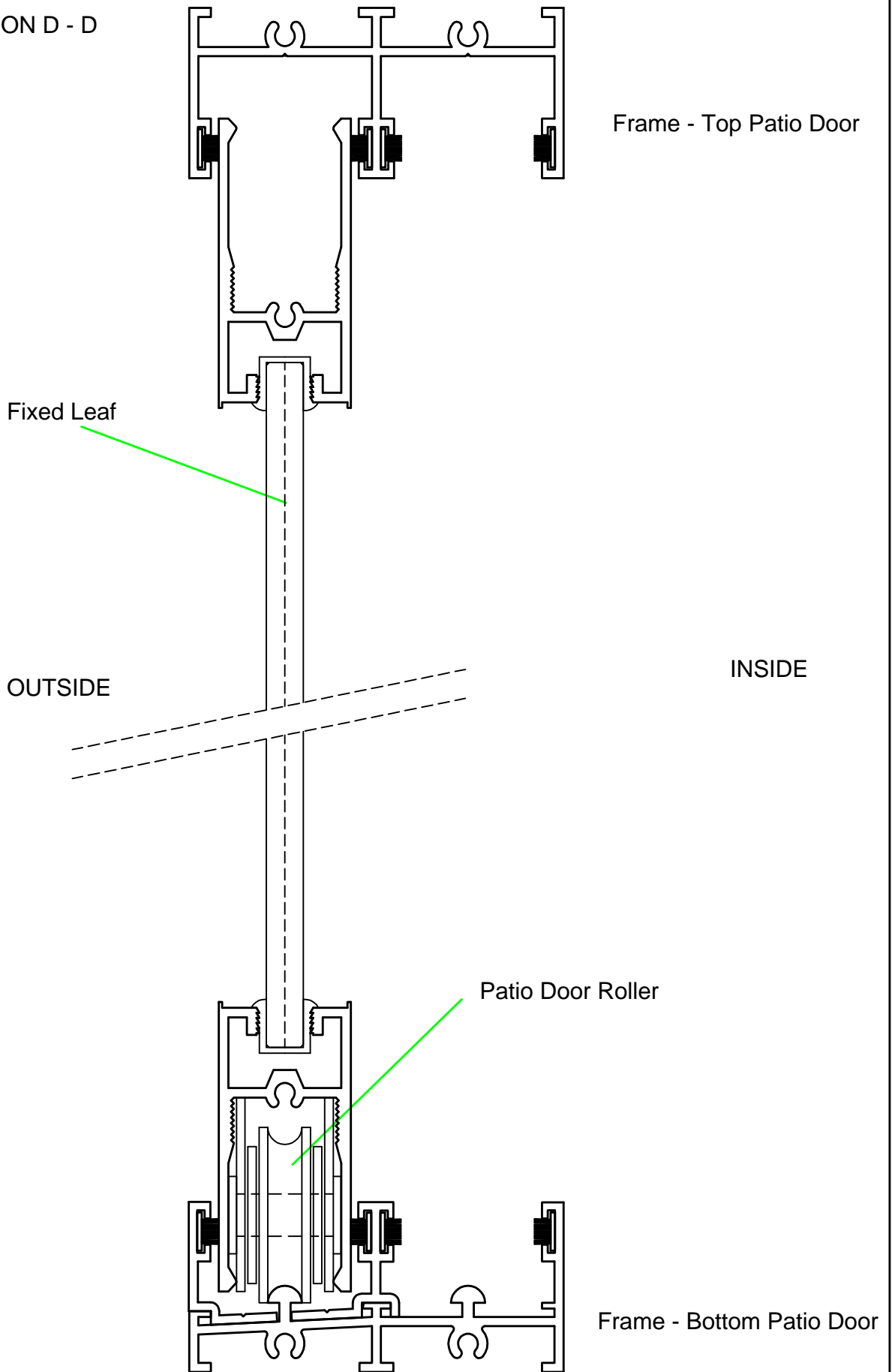

Vertical Cross Sections





SECTION E - E

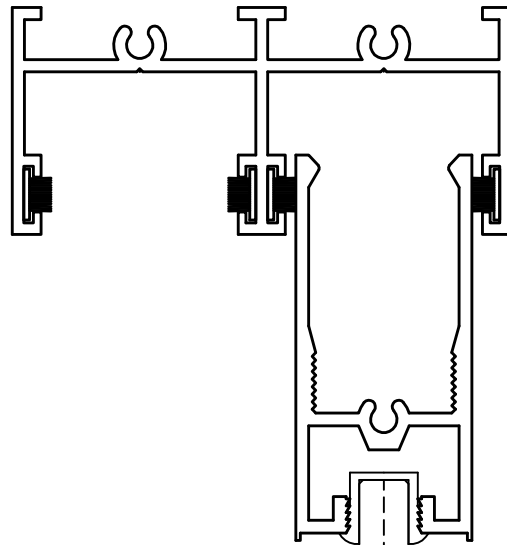

Frame - Top Patio Door

Fixed Leaf

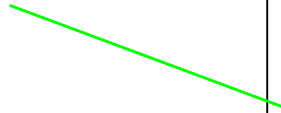

OUTSIDE

INSIDE

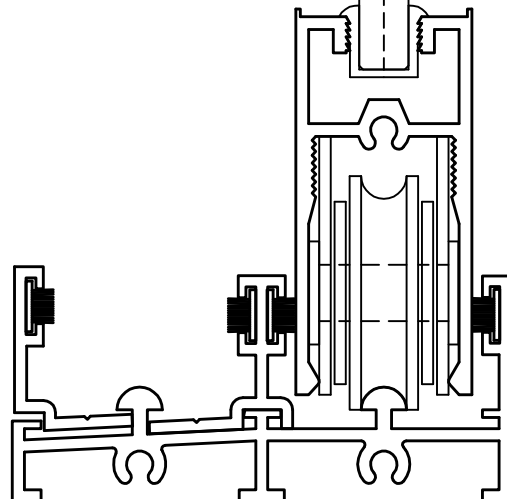

Frame - Bottom Patio Door

Vertical Cross Sections

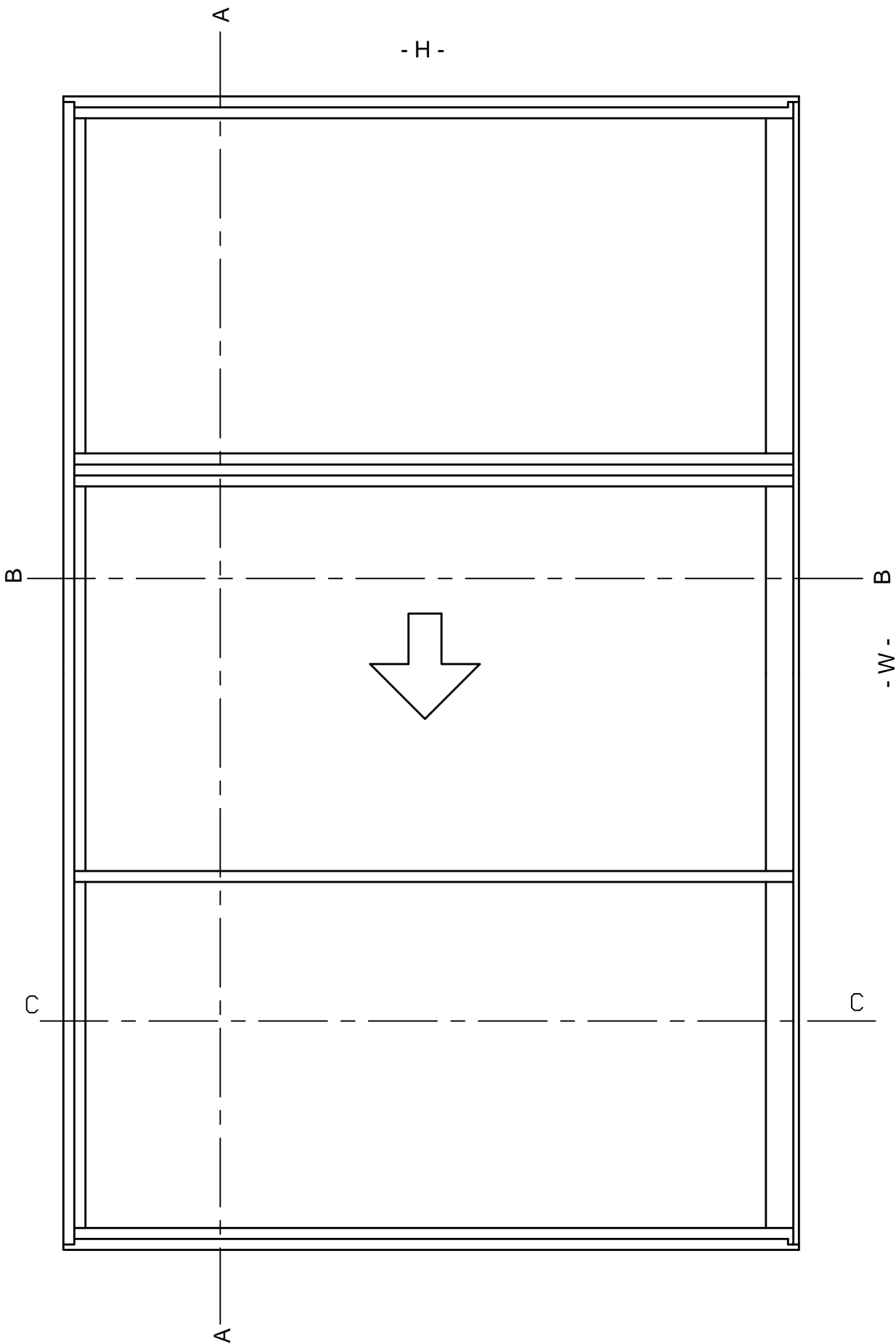

W & H are the manufacturing sizes,  
NOT the opening sizes in the building. OXO TYPE SLIDING DOOR



## SECTION A - A

Frame - Stile Patio Door

Inside

Frame - Stile Patio Door

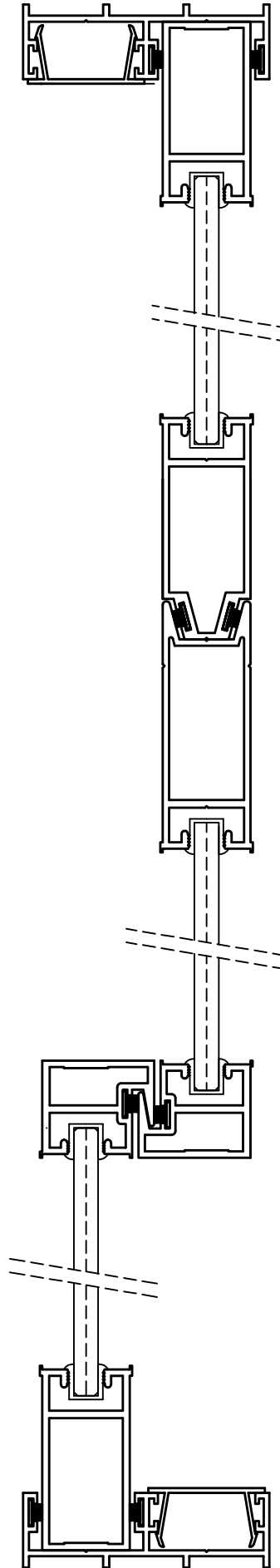

Refer to OX for SECTION B - B AND SECTION C - C

Outside

Fixed panel

Bi-Parting Lock Stiles Patio Door

Interlock Patio Door

OXO Type Sliding Door with Alternate meeting stiles  
Overall Horizontal Details

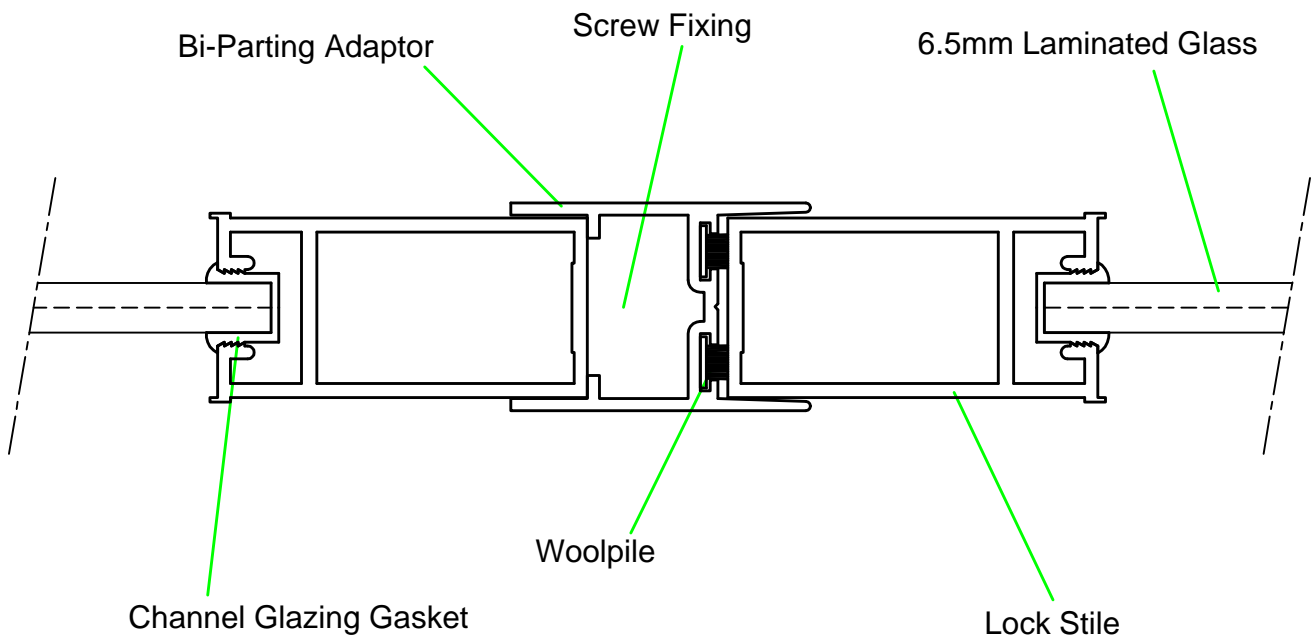
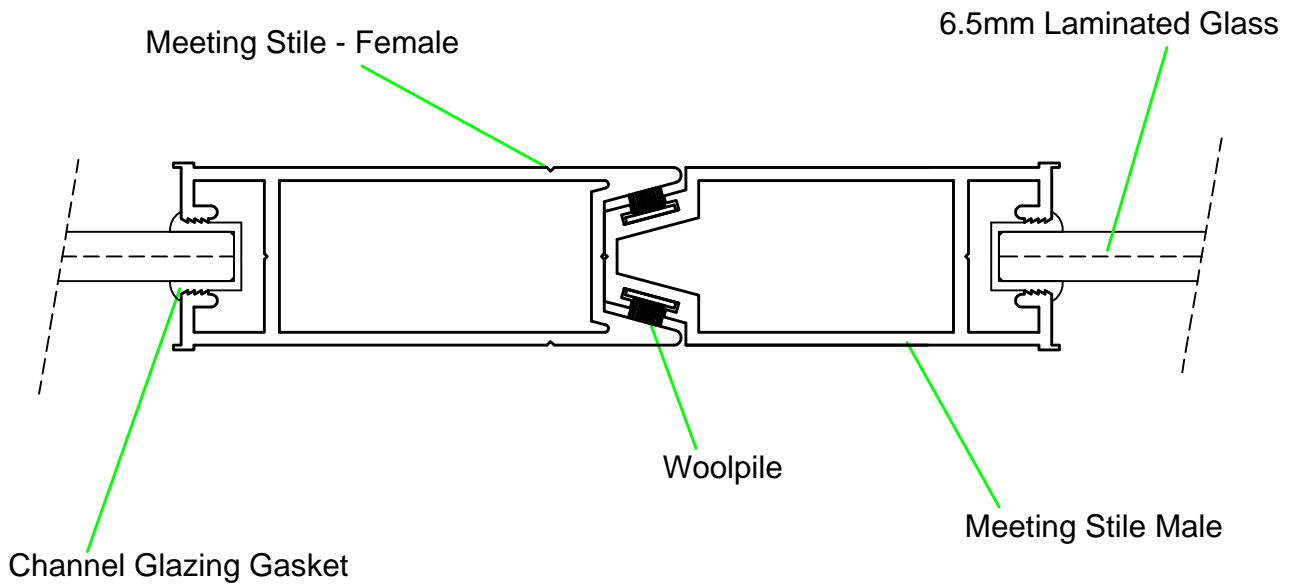

Bi-Parting Lock Stiles Patio Door Horizontal Details

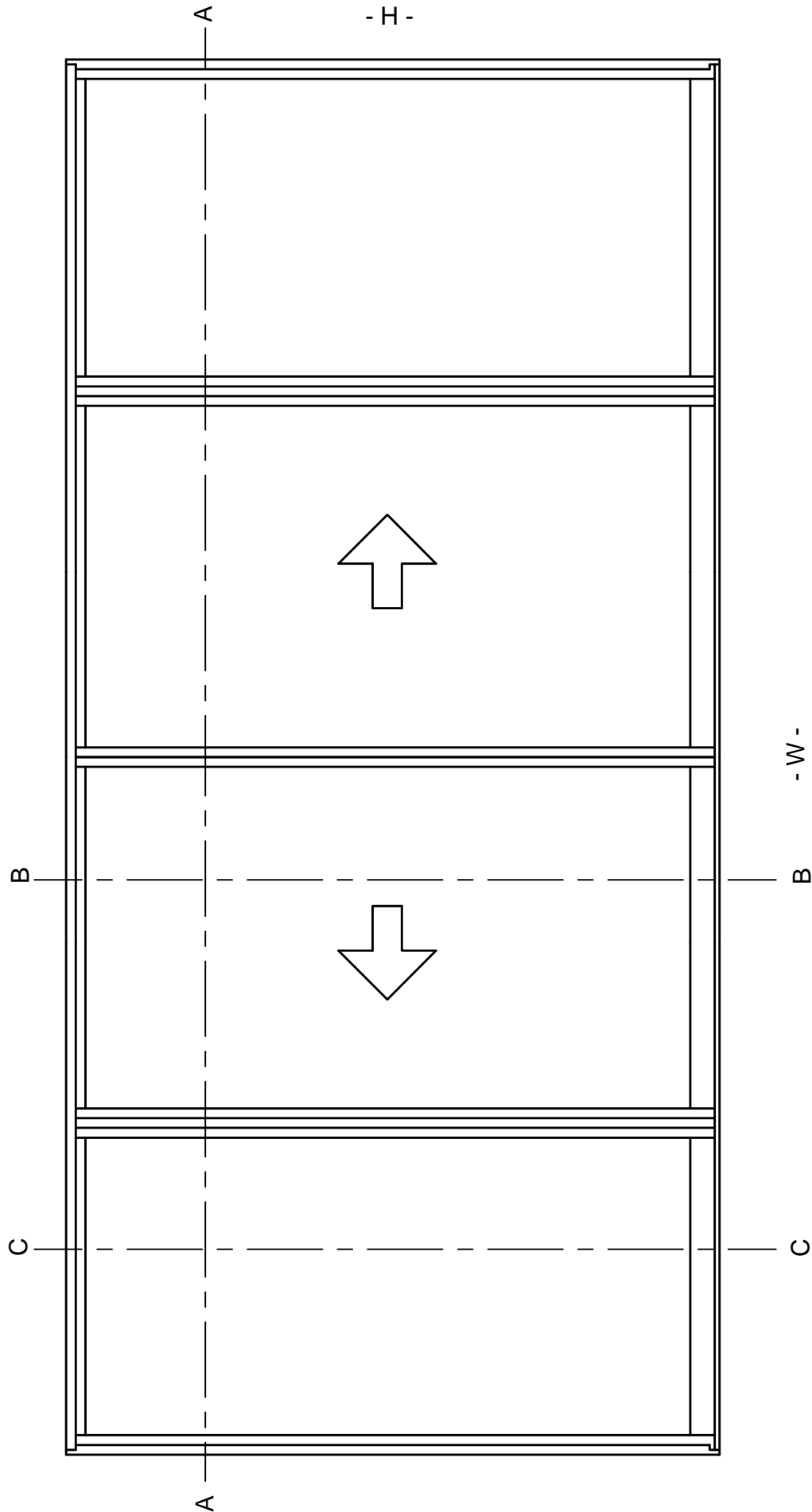

W & H are the manufacturing sizes,  
NOT the opening sizes in the building. OXXO TYPE SLIDING DOOR



## SECTION A - A

Refer to OX for SECTION B - B AND SECTION C - C

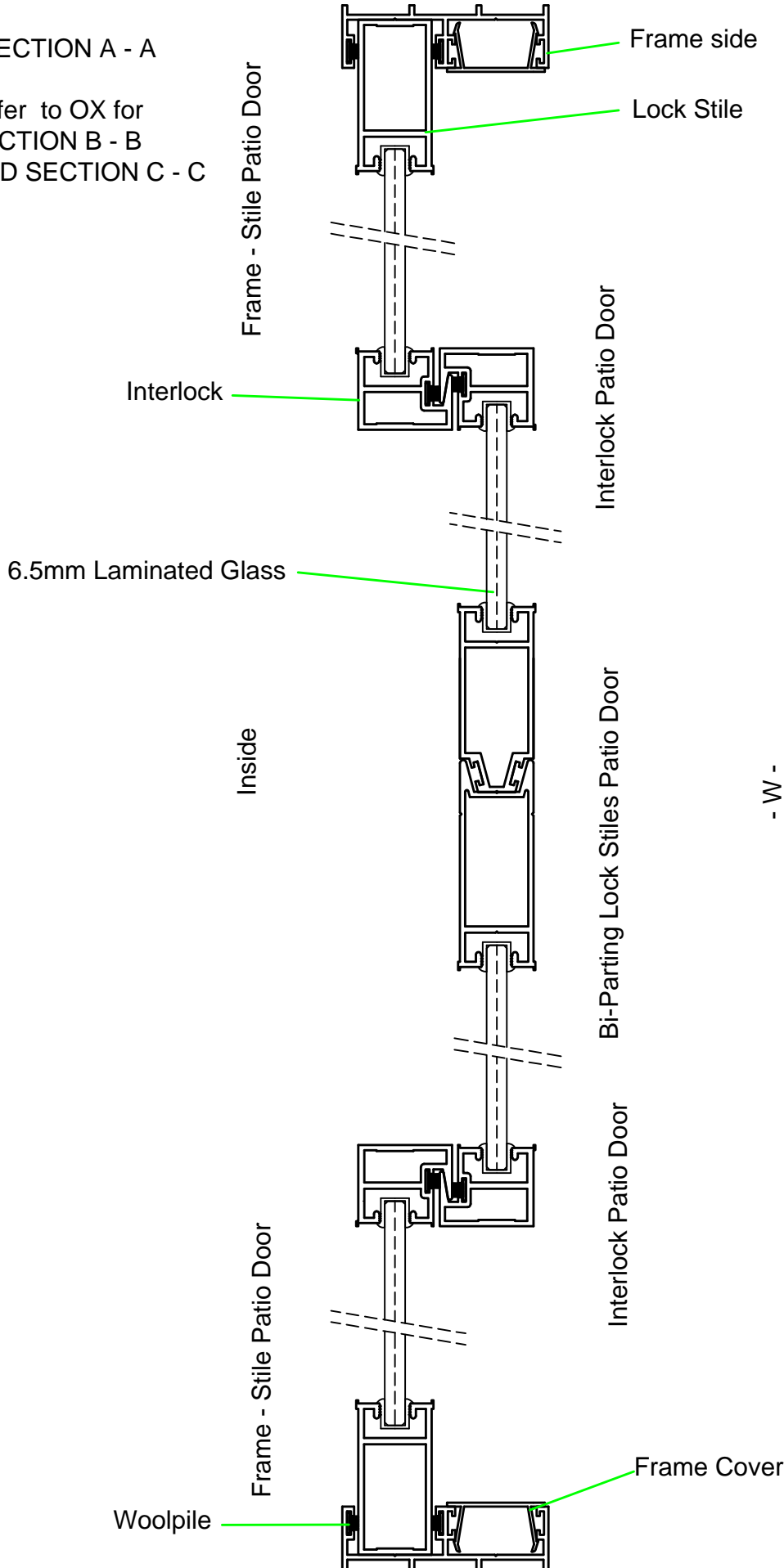

OXXO Type Sliding Door with Alternate meeting stiles  
Overall Horizontal Details

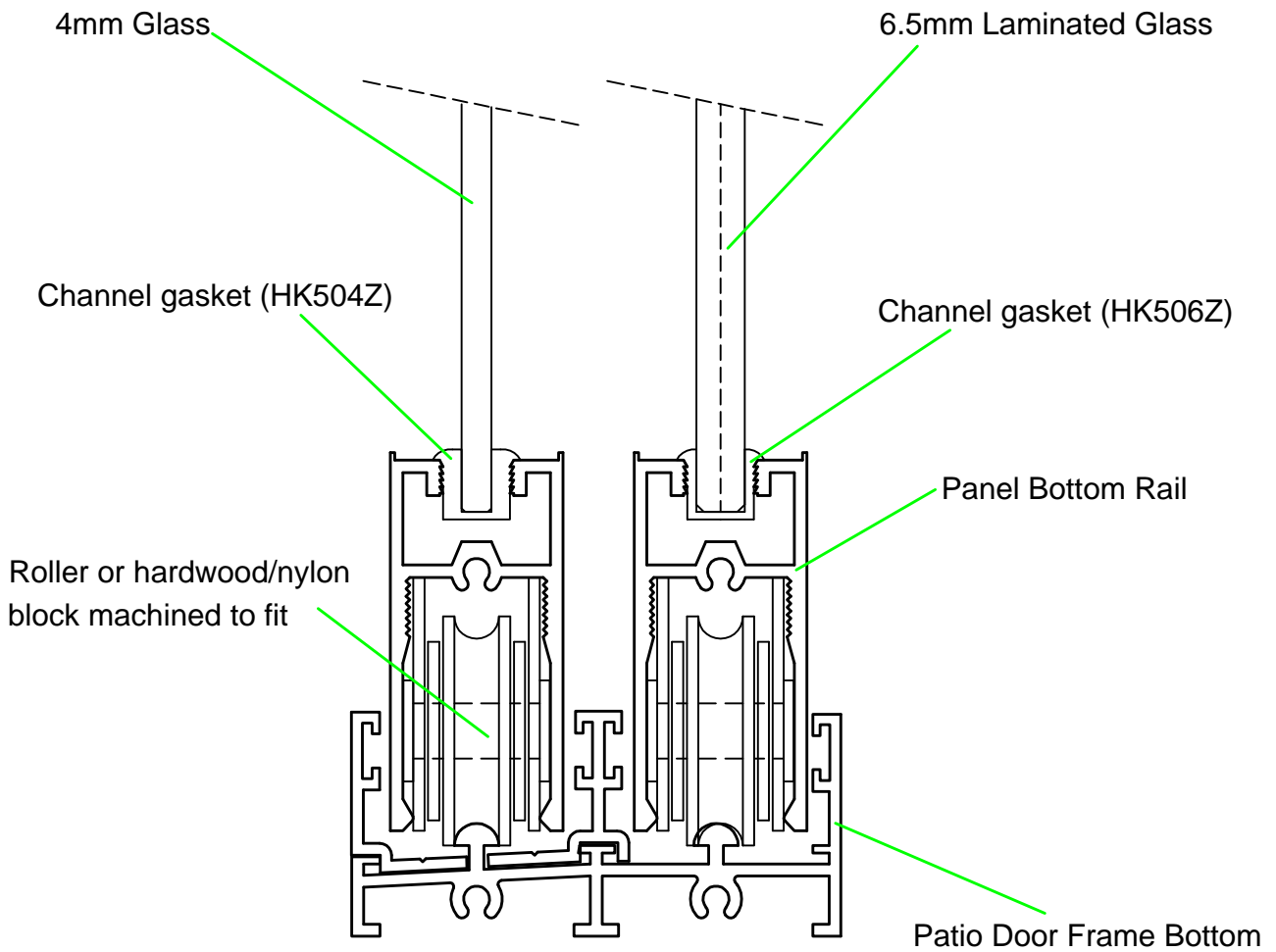

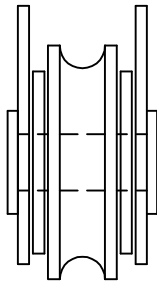

Patio Door Roller 1532n  
Code HG003Z



Woolpile 6.7 \* 450  
Code HL005Z

### NIGHT LOCKS

Patio Door Night Lock - Nat  
Code HG001N

Patio Door Night Lock - Bronze  
Code HG001D

### DOOR HANDLES

Interlock Patio Door Handles  
11101 - Locking - Key out  
Code HG016B

11201 - Double Deadlocking  
Code HG017B

Double Deadlocking HF103B  
11300 - Dummy  
Code HG725Z



EPDM Channel Gasket - 4mm Glass  
Code HK504Z

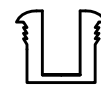

EPDM Channel Gasket - 5mm Glass  
Code HK505Z



EPDM Channel Gasket - 6mm Glass  
Code HK507Z

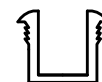

EPDM Channel Gasket - 6.5mm Glass  
Code HK506Z